

UNIVERSITY OF ILLINOIS
AT URBANA-CHAMPAIGN

Microwave cavities

Physics 401, Spring 2019
Eugene V. Colla



Agenda

- **Waves in waveguides**
- **Standing waves and resonance**
- **Setup**
- **Experiment with microwave cavity**
- **Comments on Bragg diffraction experiment**



Reminder: Propagation of Plane Waves

Maxwell's Equations

$$\nabla \vec{D} = 0$$

$$\nabla \vec{B} = 0$$

$$\nabla \times \vec{E} = -\frac{\partial \vec{B}}{\partial t}$$

$$\nabla \times \vec{H} = \frac{\partial \vec{D}}{\partial t}$$

uniform plane wave traveling
in z-direction $\rightarrow \mathbf{H} \perp \mathbf{E}$

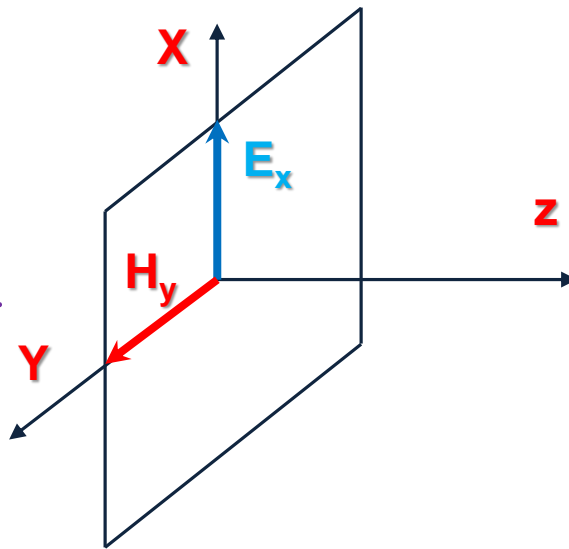

wave equation

$$\frac{\partial^2 E_x}{\partial z^2} = \frac{1}{v^2} \frac{\partial^2 E_x}{\partial t^2}$$

general form of solution

$$E_z(z, t) = f\left(t - \frac{z}{v}\right) + g\left(t + \frac{z}{v}\right)$$

propagation speed

$$v = \frac{1}{\sqrt{\epsilon\mu}}$$

$$Z = \sqrt{\frac{\mu}{\epsilon}}$$

E vs H

$$H_y = \sqrt{\frac{\epsilon}{\mu}} E_x$$

$$E_x = Z H_y$$

$$E_x = E_0 e^{i(\omega t - kz)}$$



Wave Propagation in Wave Guides

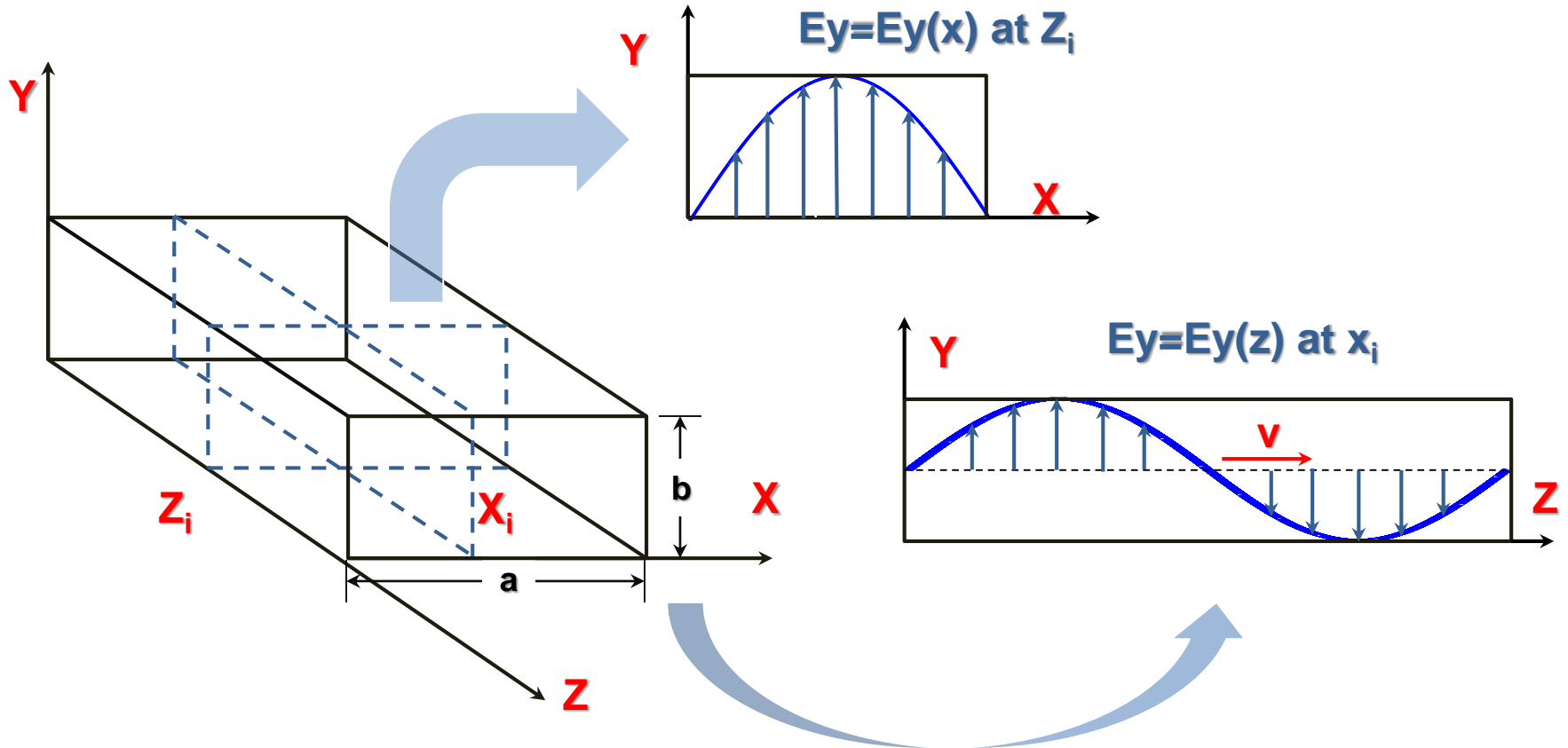

$$E_y = E_0 \sin k_x x \cdot e^{i(\omega t - kz)}$$



Standing Waves in Cavities

$$E_y = E_0 \sin k_x x \cdot e^{i(\omega t - kz)}$$

+

$$E_y = E_0 \sin k_x x \cdot e^{i(\omega t + kz)}$$

=

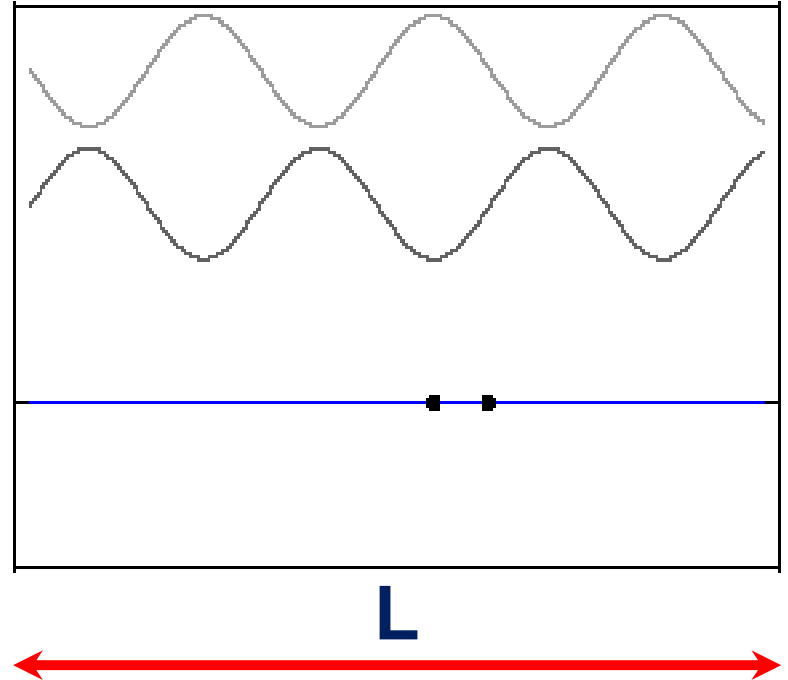

$$L = n \cdot \lambda / 2$$



Standing Waves in Cavities

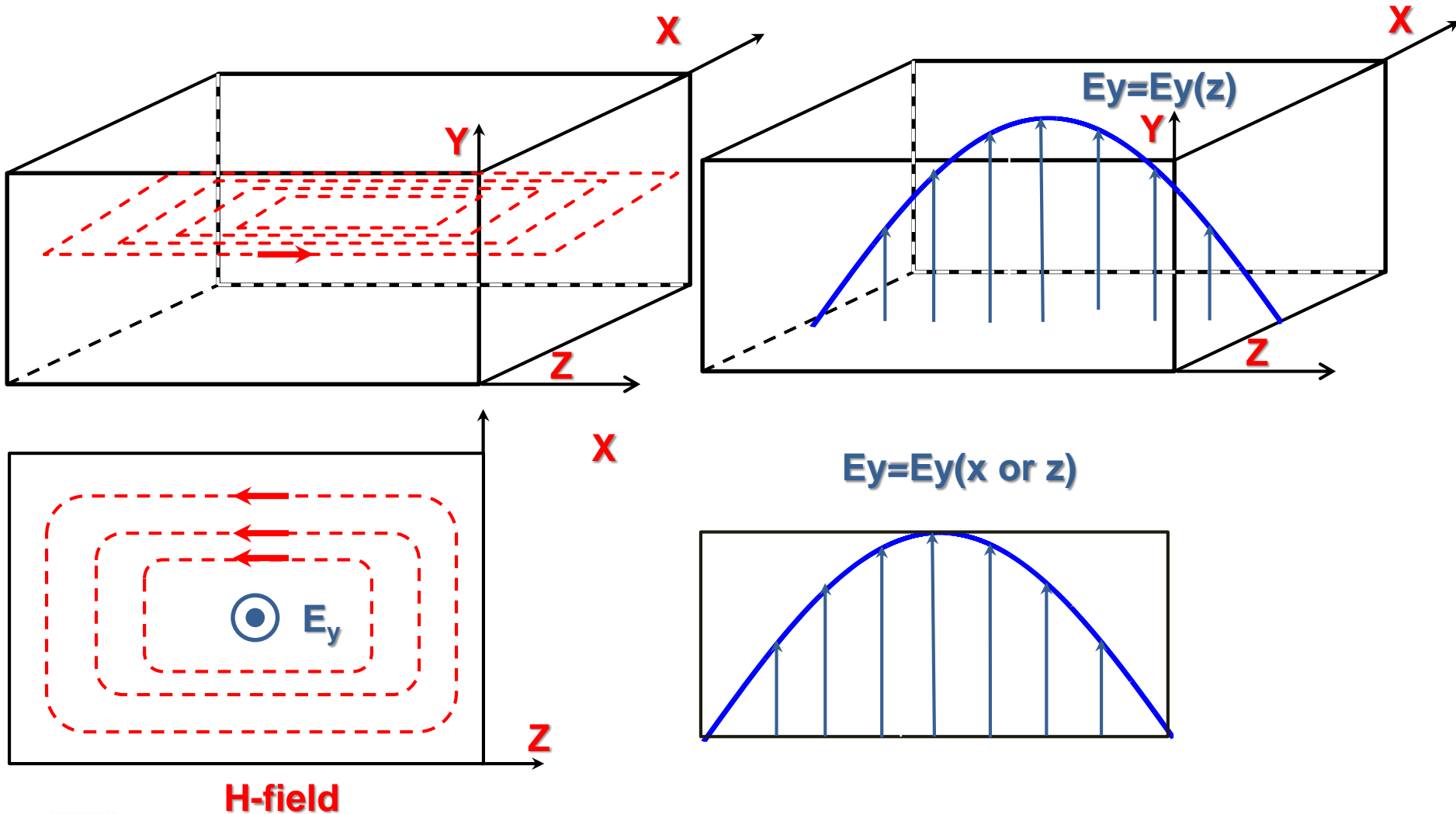

Resonances for transverse Electric Waves

$$\omega_{mnp}^2 = v_0^2 \left[\left(\frac{m\pi}{a} \right)^2 + \left(\frac{n\pi}{b} \right)^2 + \left(\frac{p\pi}{c} \right)^2 \right]$$

v_0^2 -phase velocity

TE₁₀₁ mode: m=1, n=0, p=1

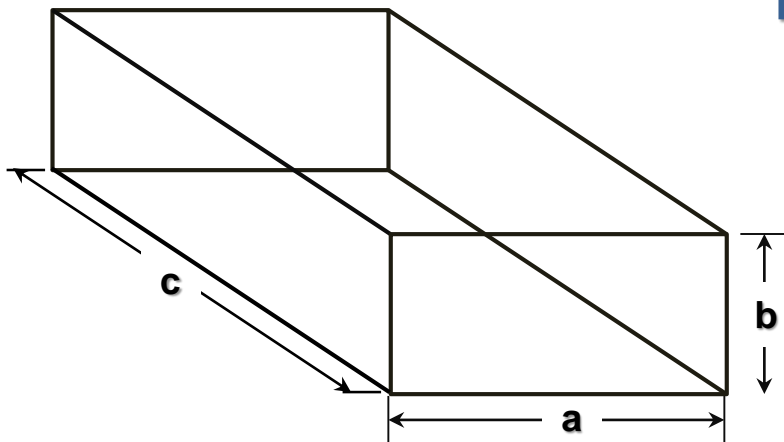

$$\omega_{101}^2 = v_0^2 \pi^2 \left[\left(\frac{1}{a} \right)^2 + \left(\frac{1}{c} \right)^2 \right]$$



Equivalent Circuit

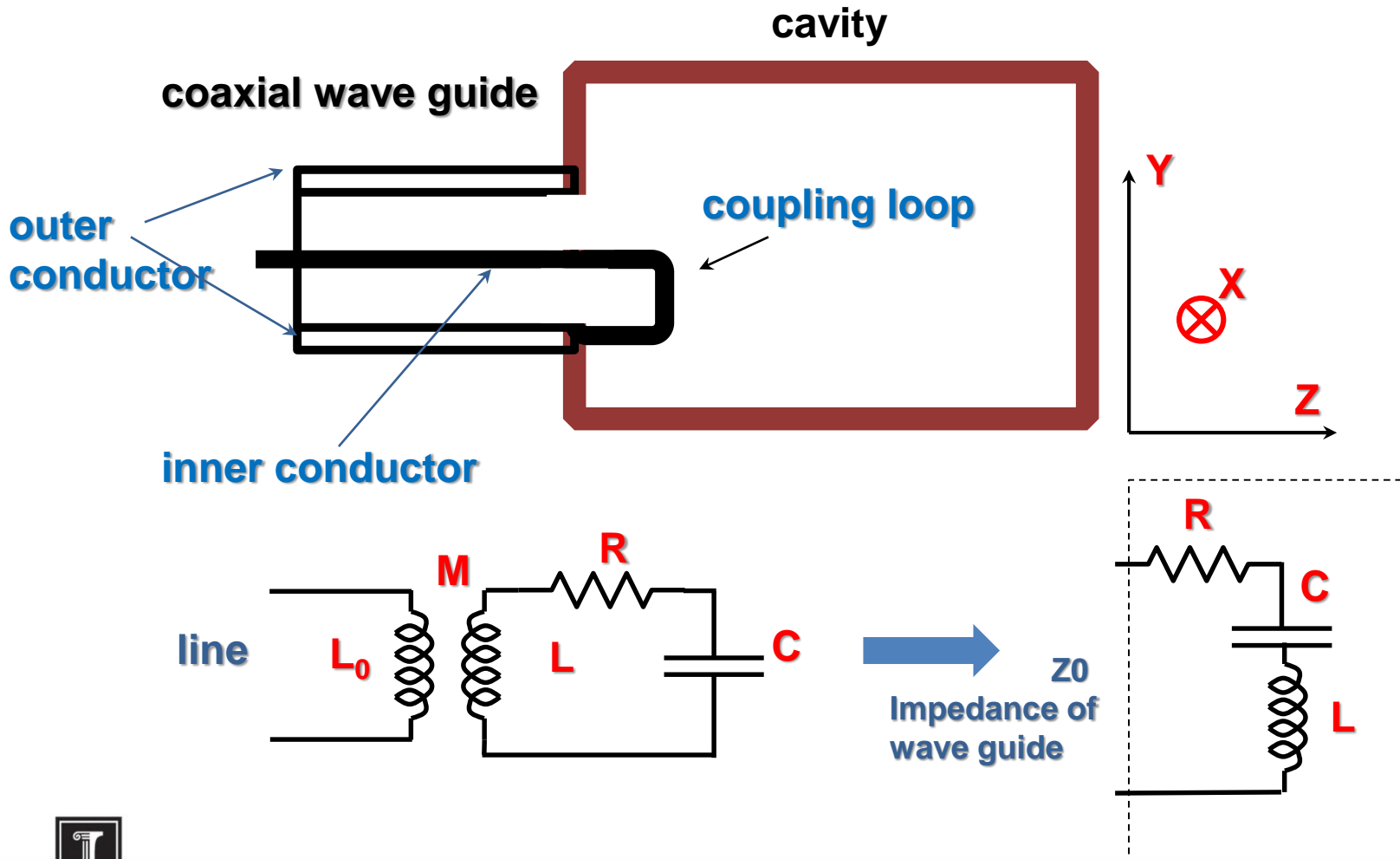

Coupling between Wave Guide and Cavity

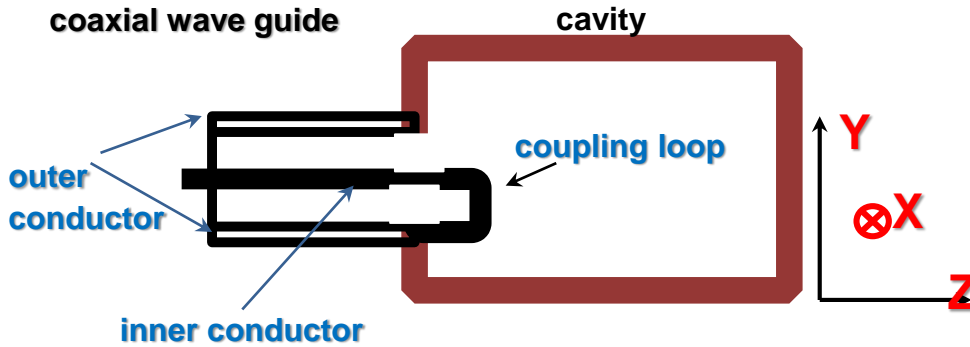

$$Q_L = \frac{\omega L}{R + Z_0}$$

$$Q_L = \frac{\omega L}{Z_0 \left(1 + \frac{R}{Z_0}\right)} = \frac{Q_0}{(1 + \beta)}$$

β : coupling coefficient

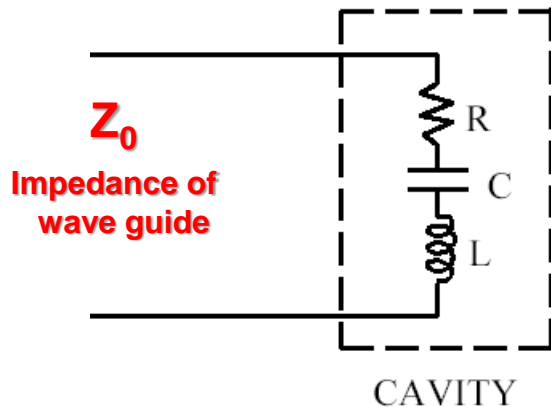

Maximum power transfer:

$$Z_0 = R \rightarrow \beta = 1$$

$$\Rightarrow Q_L = \frac{1}{2} Q_0,$$

Q_0 - quality factor without external load



Microwaves in Cavities. Overview of the Experiment.

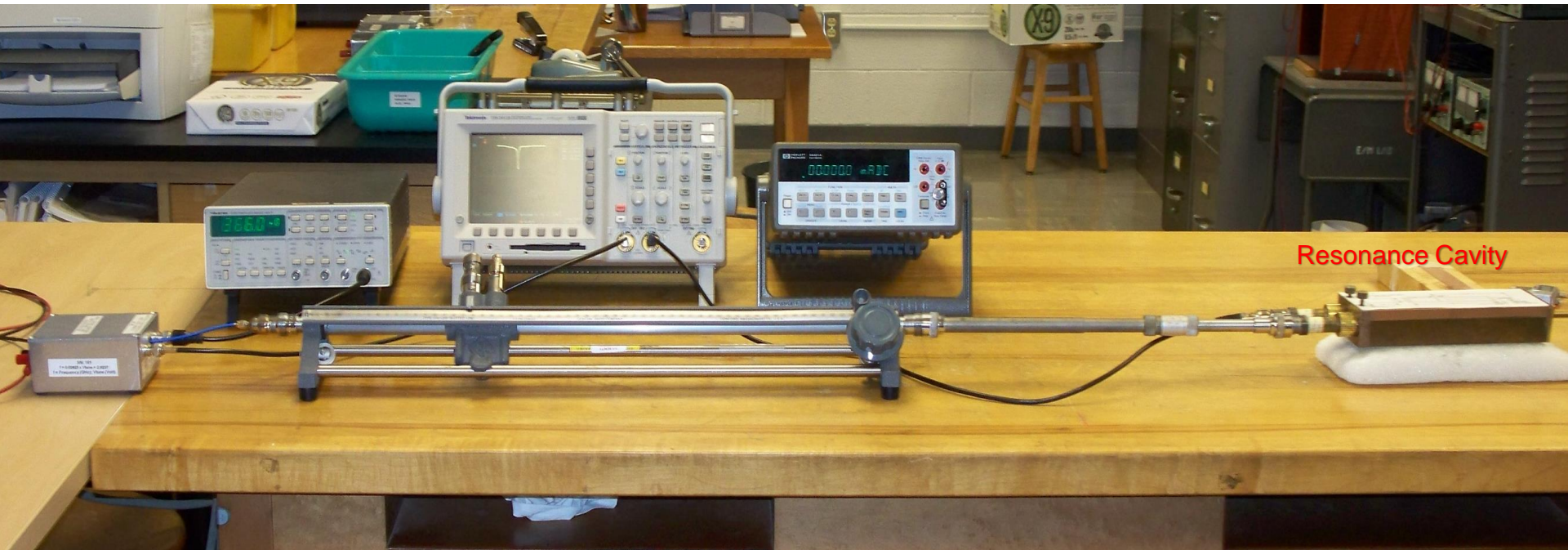

4/1/2019

Gunn diode
MW oscillator

illinois.edu

10

Microwaves in Cavities.

The Setup of the Experiment.

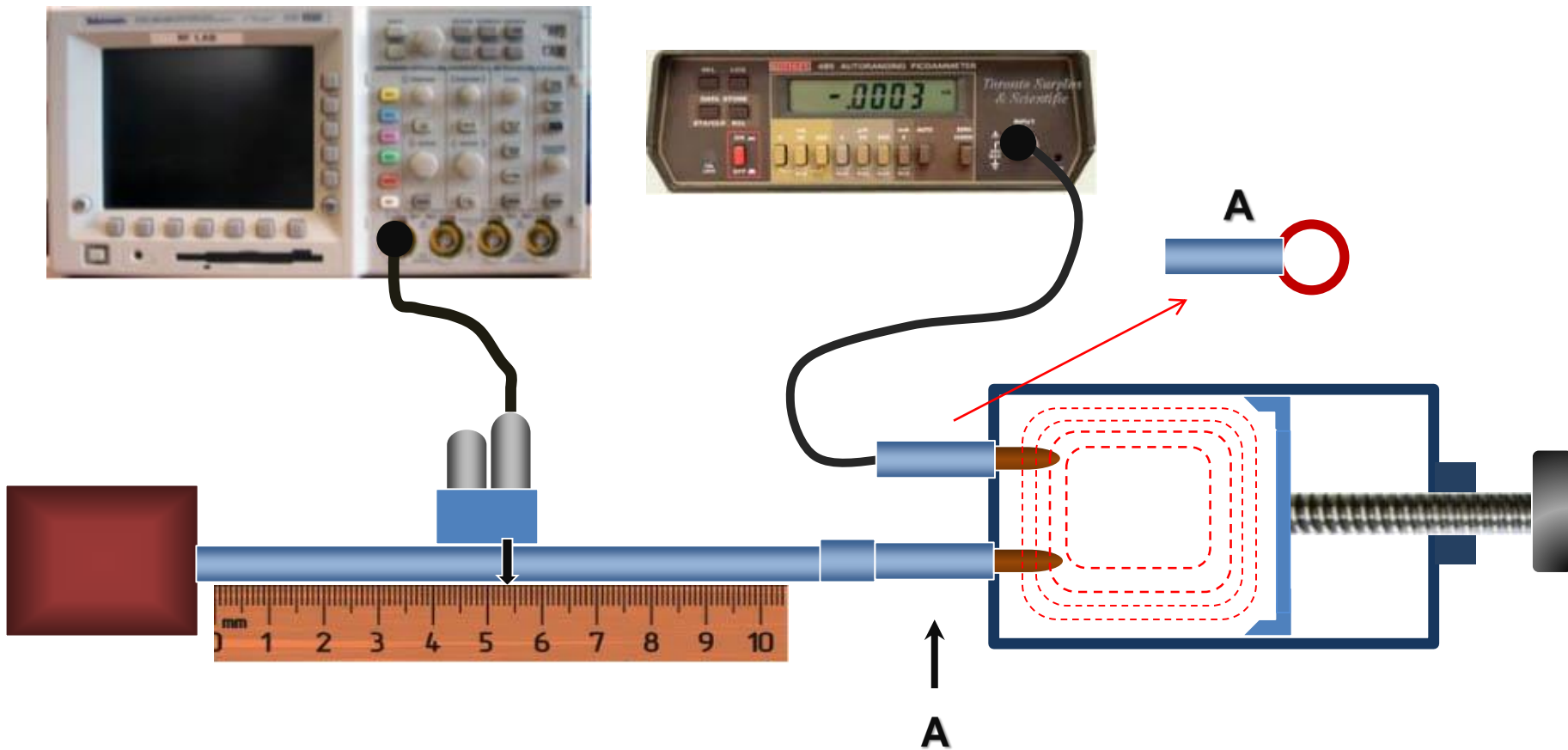

Experiment. Wavelength measurement.

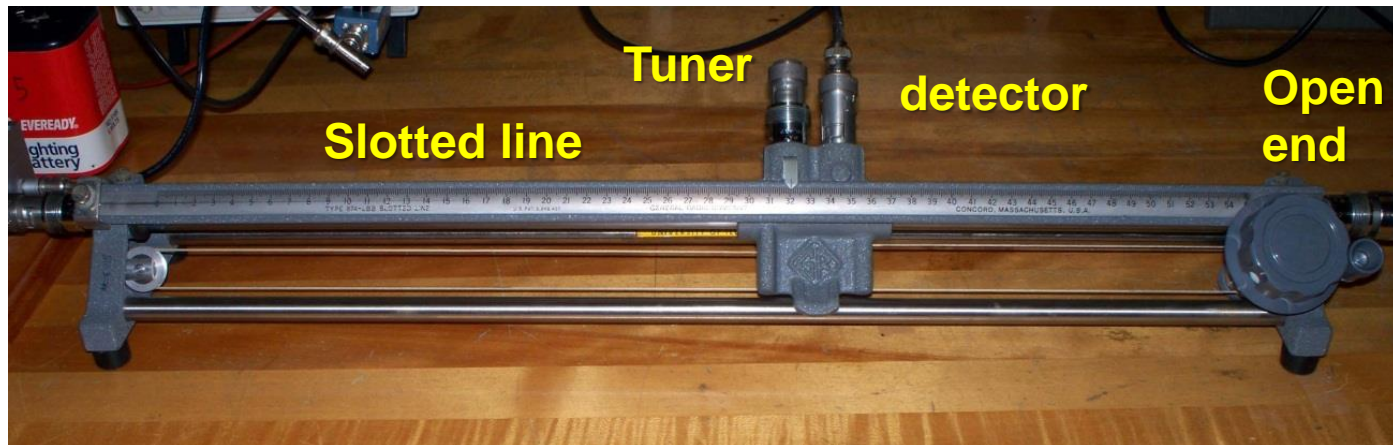

Use detector to find distance between minimums in the slotted line (wave guide)



Experiment. Wavelength measurement.

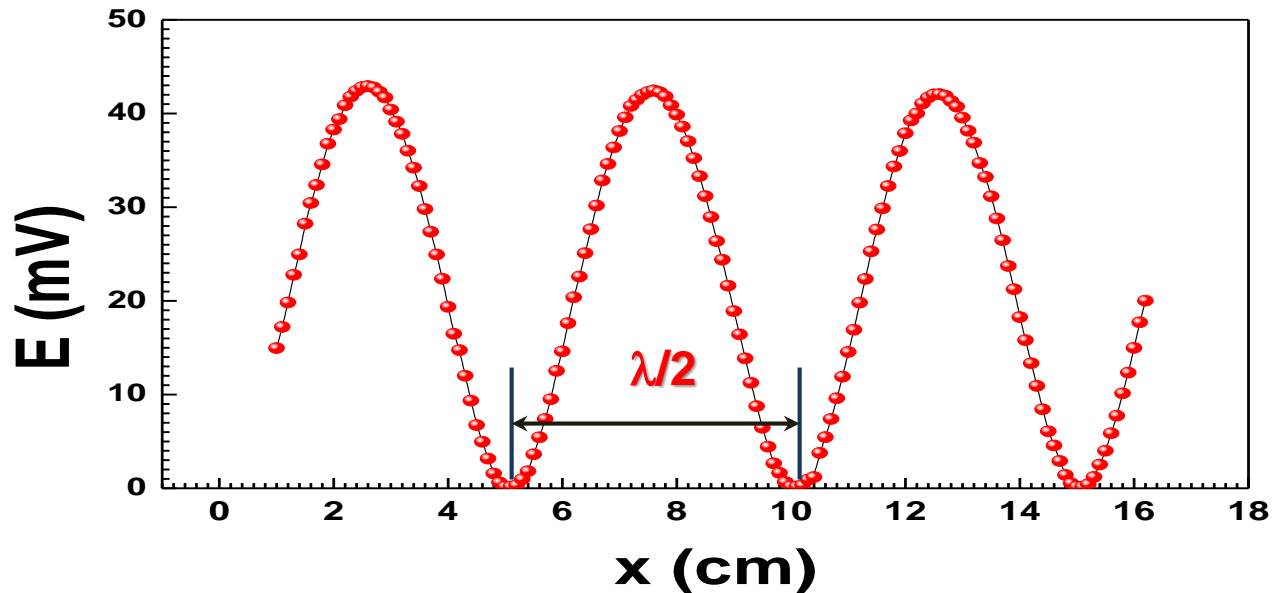

Use detector to find distance between minima in the slotted line (wave guide). Distance between consequent minima correspond $\lambda/2$



Experiment. Cavity resonance.

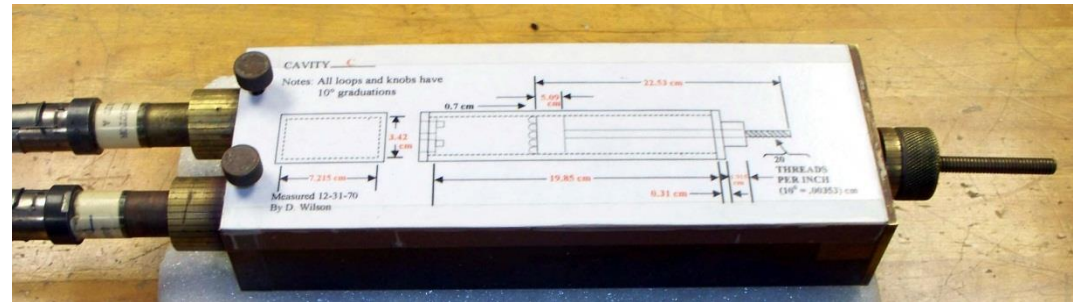
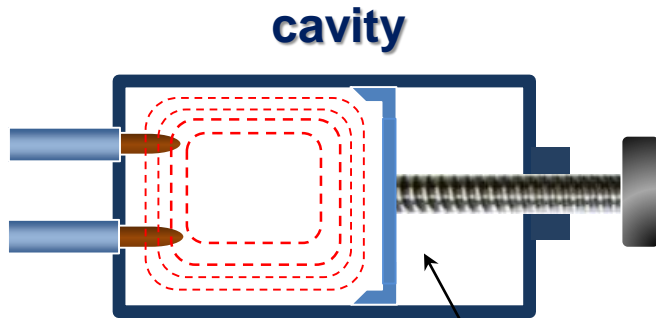

Movable plunger (c direction)

Use plunger to change the dimension of the cavity in z-direction and search for maxima in power stored using the cavity detector. Identify TE_{101} and TE_{102} .

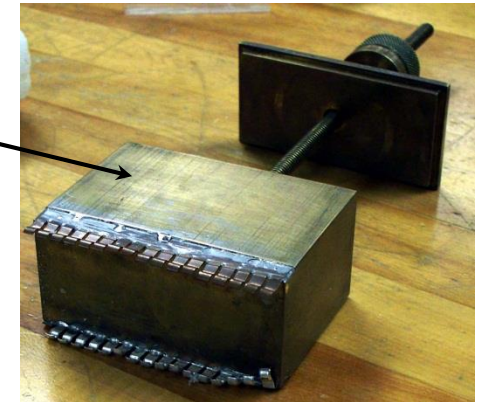

Experiment. Cavity resonance.

$$\omega_{102}^2 = v_0^2 \pi^2 \left[\left(\frac{1}{a} \right)^2 + \left(\frac{2}{c} \right)^2 \right] \quad \longrightarrow \quad f_{102} = \frac{v_0}{2} \sqrt{\left[\left(\frac{1}{a} \right)^2 + \left(\frac{2}{c} \right)^2 \right]}$$

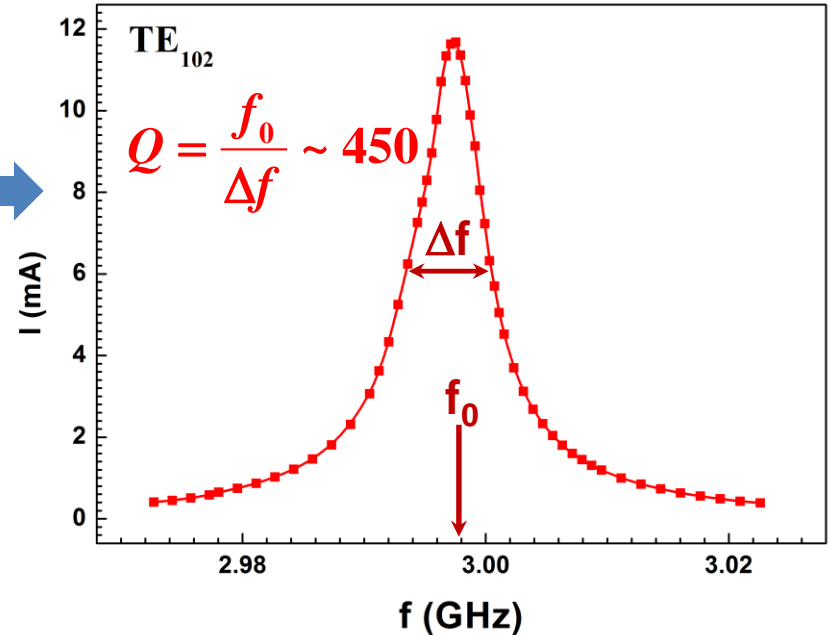
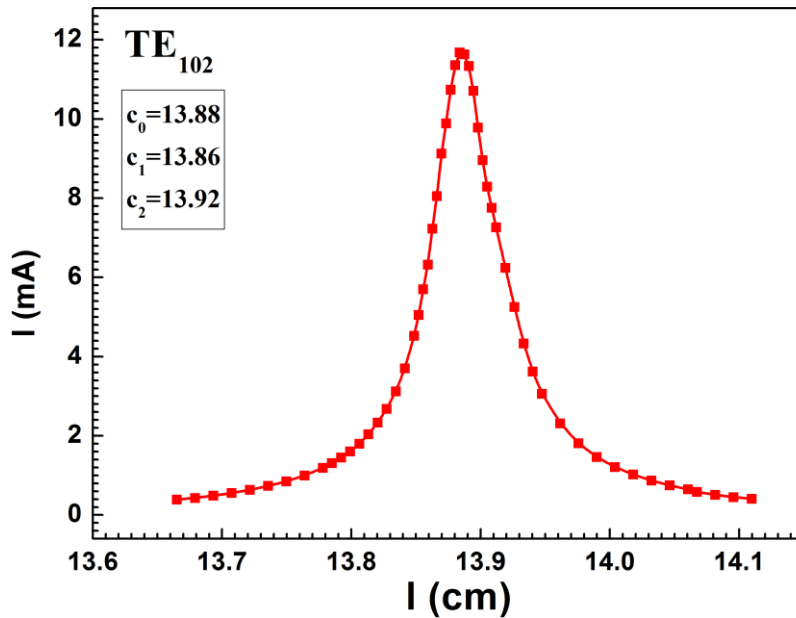

Experiment. Cavity resonance.

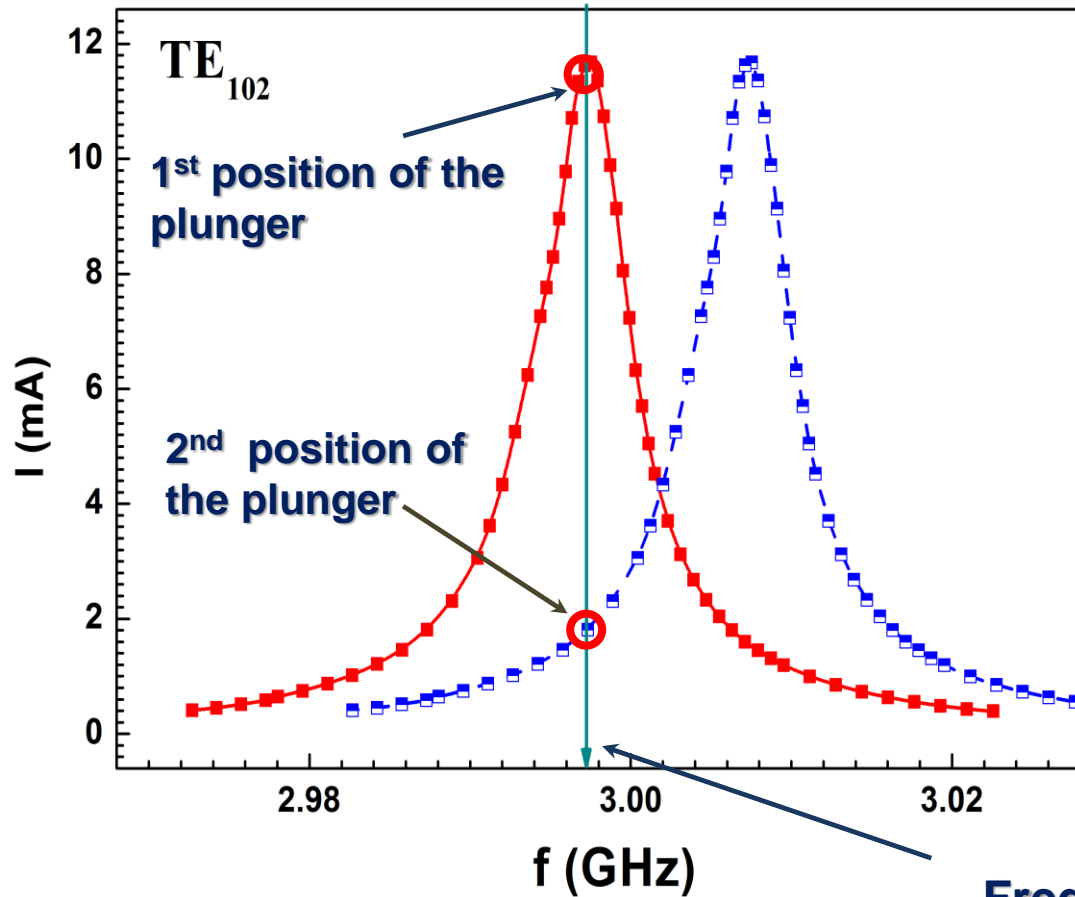

By moving the plunger we changing the resonance frequency of the cavity

Frequency of the oscillator



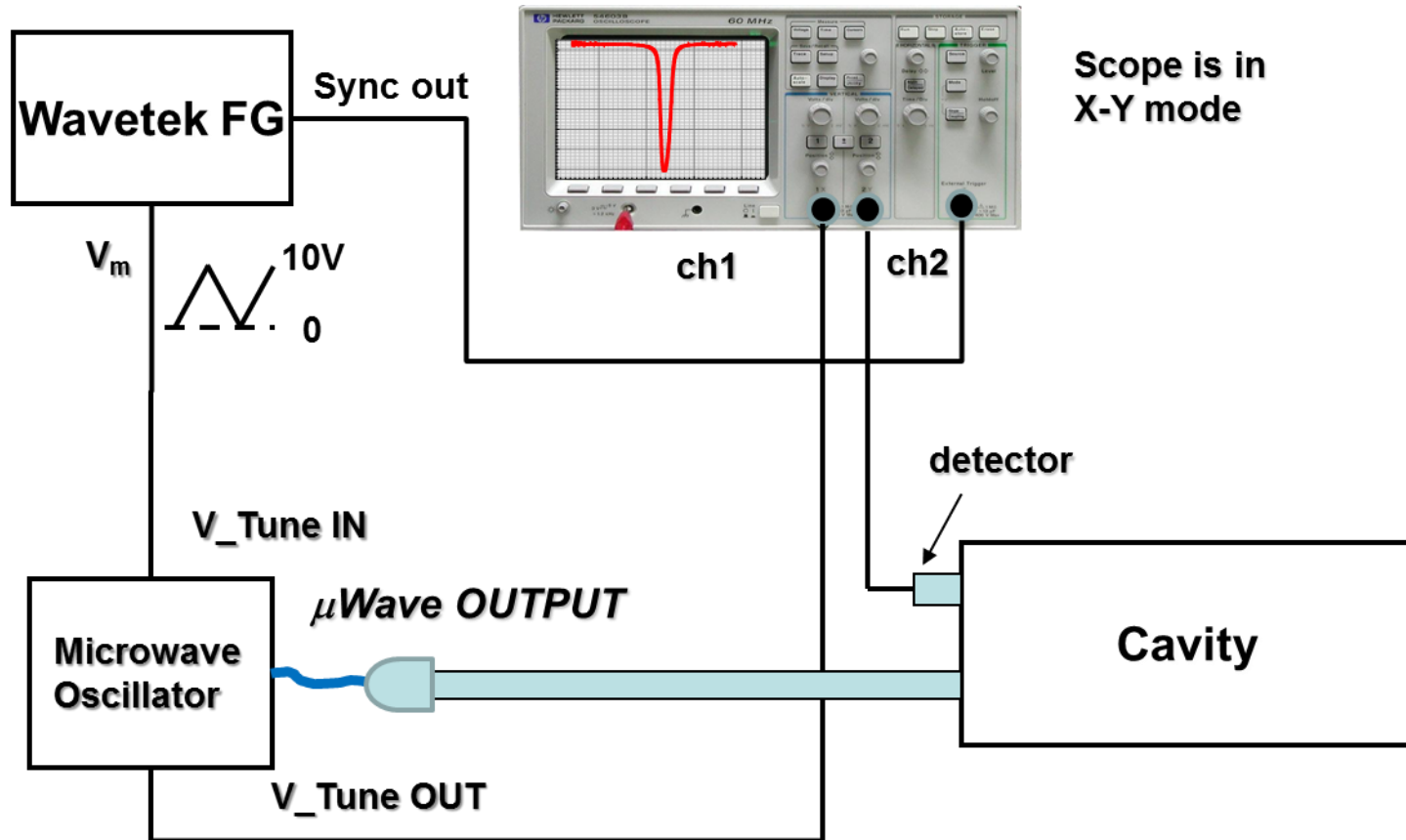

Experiment. Cavity resonance. Oscillator tuning.

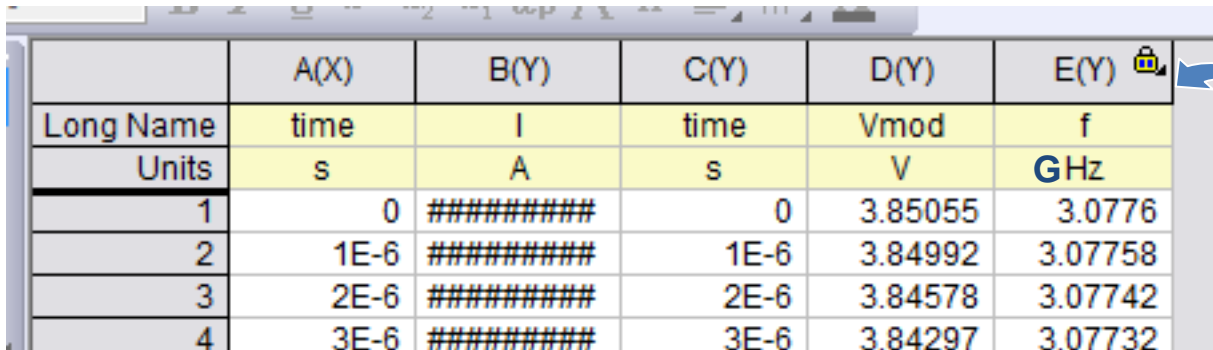

Experiment. Cavity resonance. Oscillator tuning.

1. Oscilloscope should run in X-Y mode (preferable)
2. To plot the $I(f)$ dependence you have to download both Ch1 and Ch2 data
3. Use triangular waveform as a voltage applied to modulation input of the oscillator
4. Use a proper time scale setting on the scope which could estimated from scanning frequency
5. Apply the calibration equation to calculate the frequency of the oscillator from the modulation voltage



	A(X)	B(Y)	C(Y)	D(Y)	E(Y) 
Long Name	time	I	time	Vmod	f
Units	s	A	s	V	GHz
1	0	#####	0	3.85055	3.0776
2	1E-6	#####	1E-6	3.84992	3.07758
3	2E-6	#####	2E-6	3.84578	3.07742
4	3E-6	#####	3E-6	3.84297	3.07732

$$f = 0.03706 \cdot V_{\text{mod}} + 2.9349$$



Experiment. Cavity resonance. Oscillator tuning.

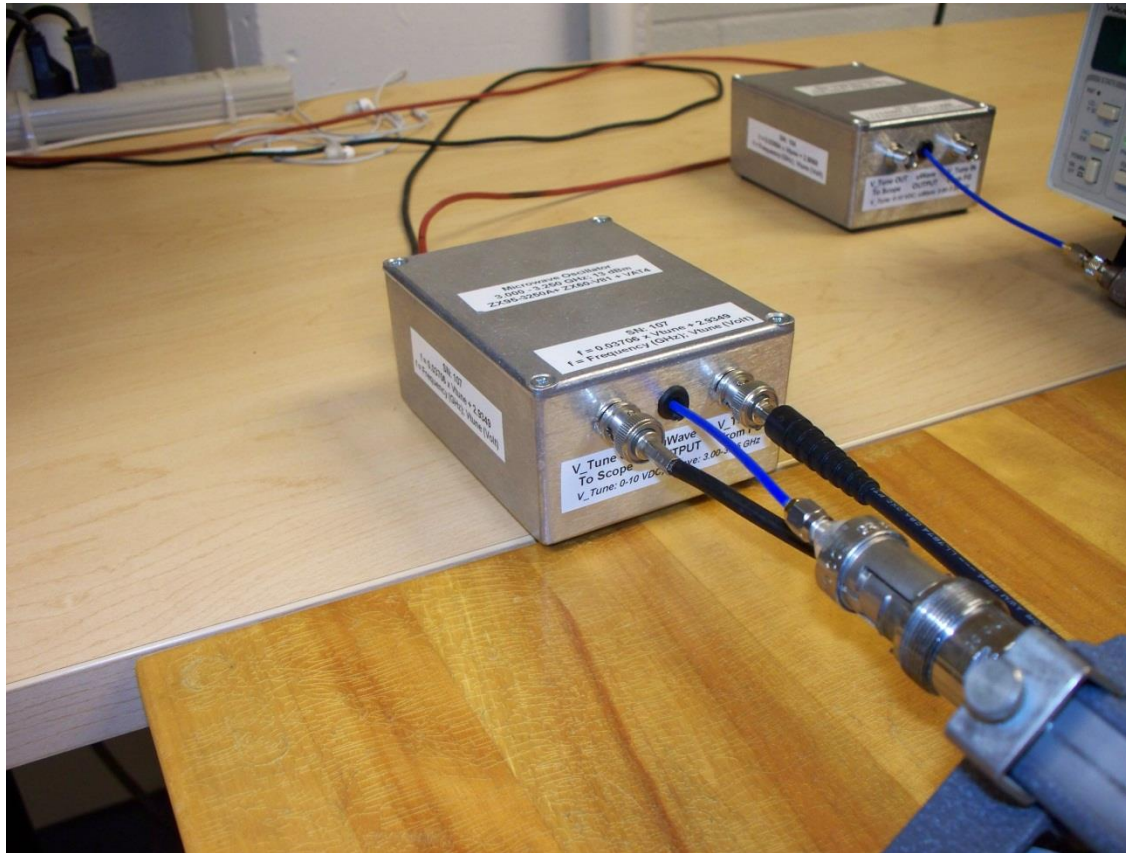

Voltage tunable
oscillator ZX95-3250a-
S+ from

 **Mini-Circuits**[®]



Experiment. Cavity resonance. Oscillator tuning.

FM Calibration for microwave oscillator

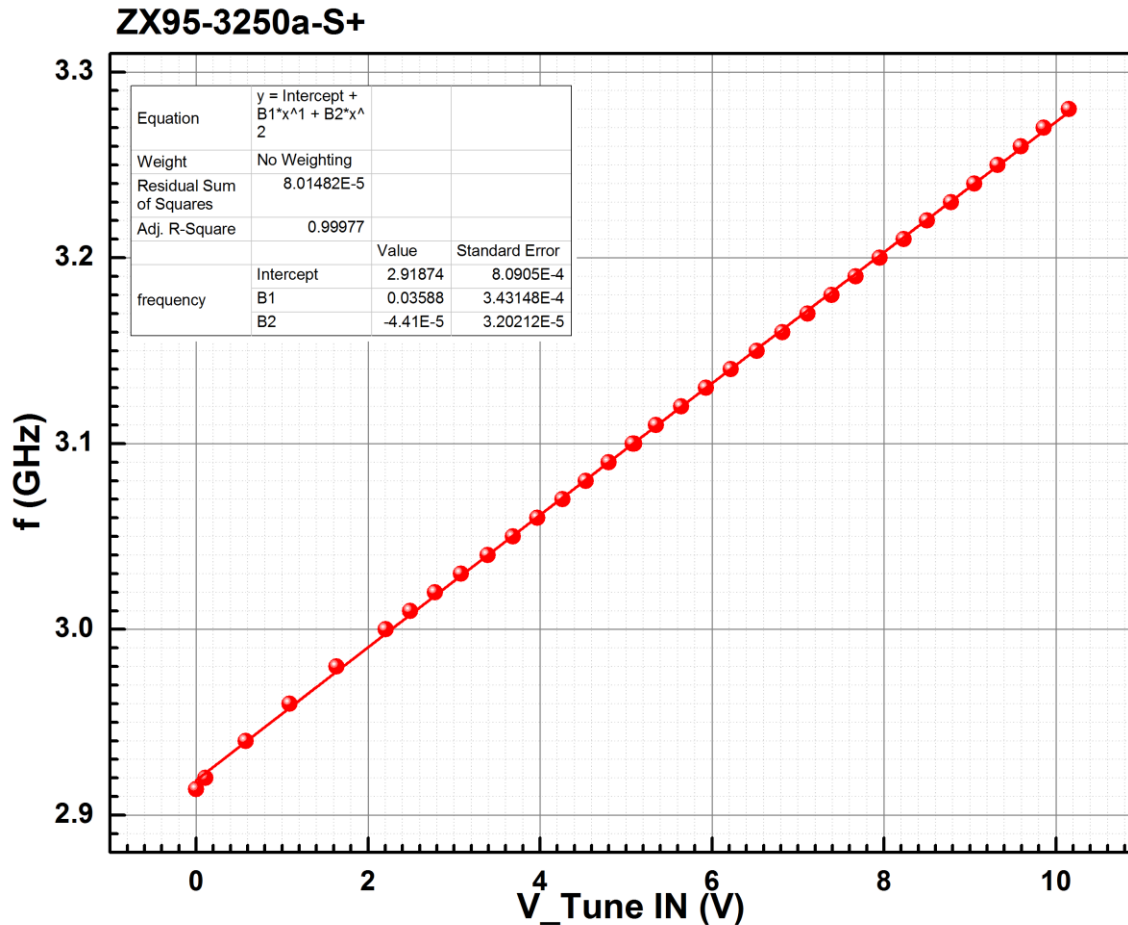

Experiment. Cavity resonance.

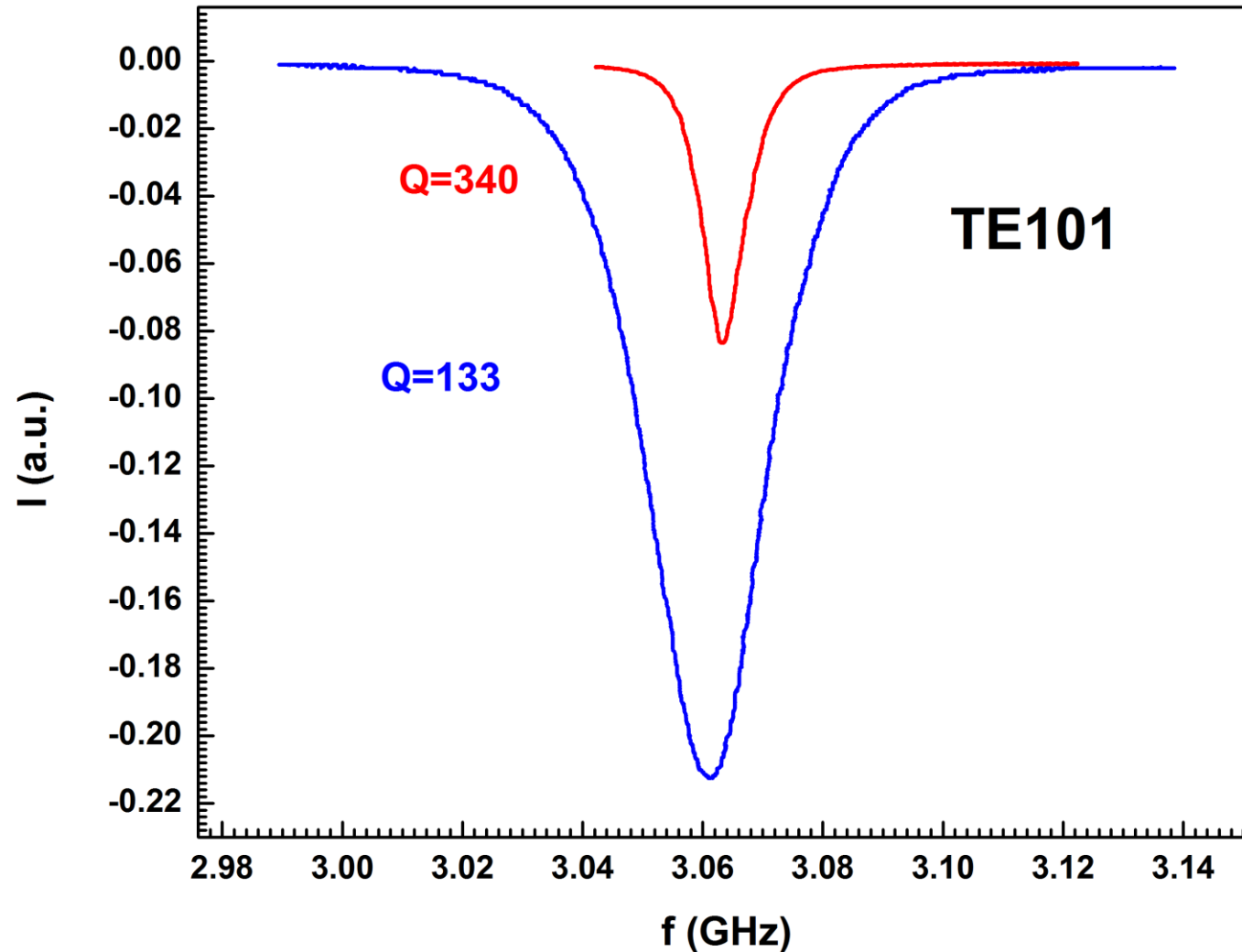

Experiment. Cavity resonance.

By changing of the coupling between oscillator and cavity we can control the quality factor of the cavity resonance but in the same time we changing the power delivered to the cavity

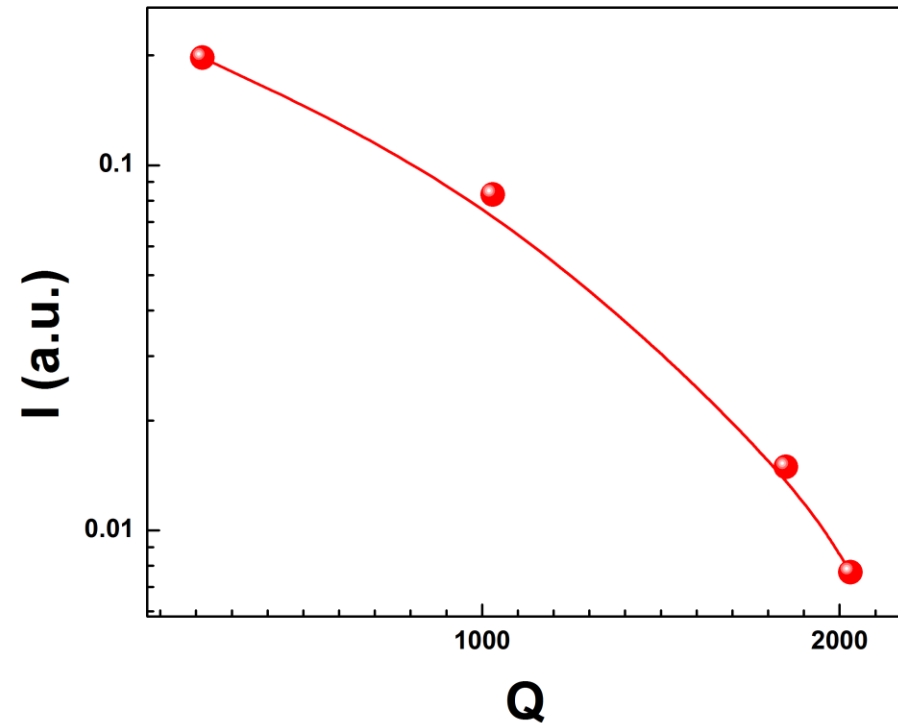
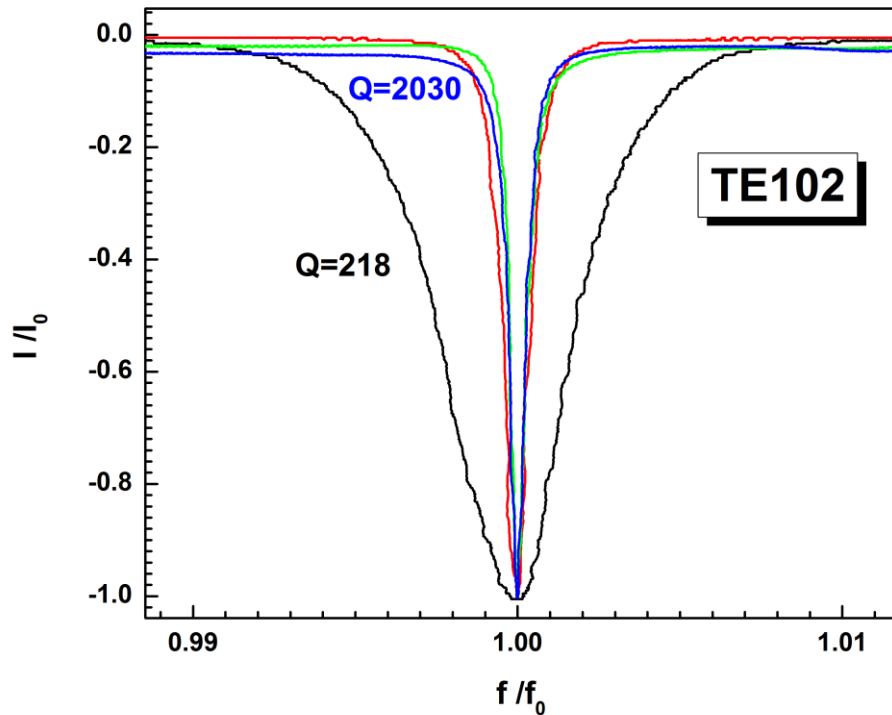

Experiment. Coupling: Detecting of the Magnetic field.

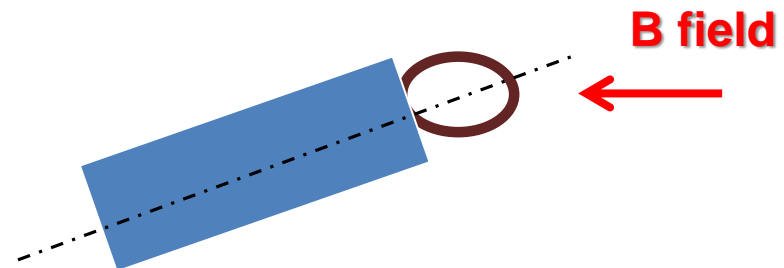
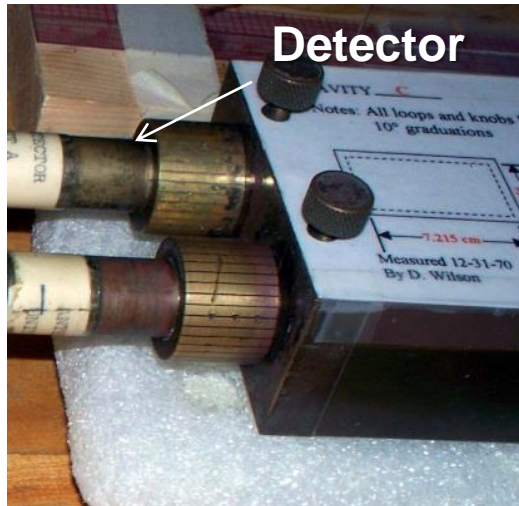

**While in resonance: turn orientation of the input loop from the vertical direction in 10° steps to 360° .
Read cavity detector.**

Experiment. Coupling: Detecting of the Magnetic field.

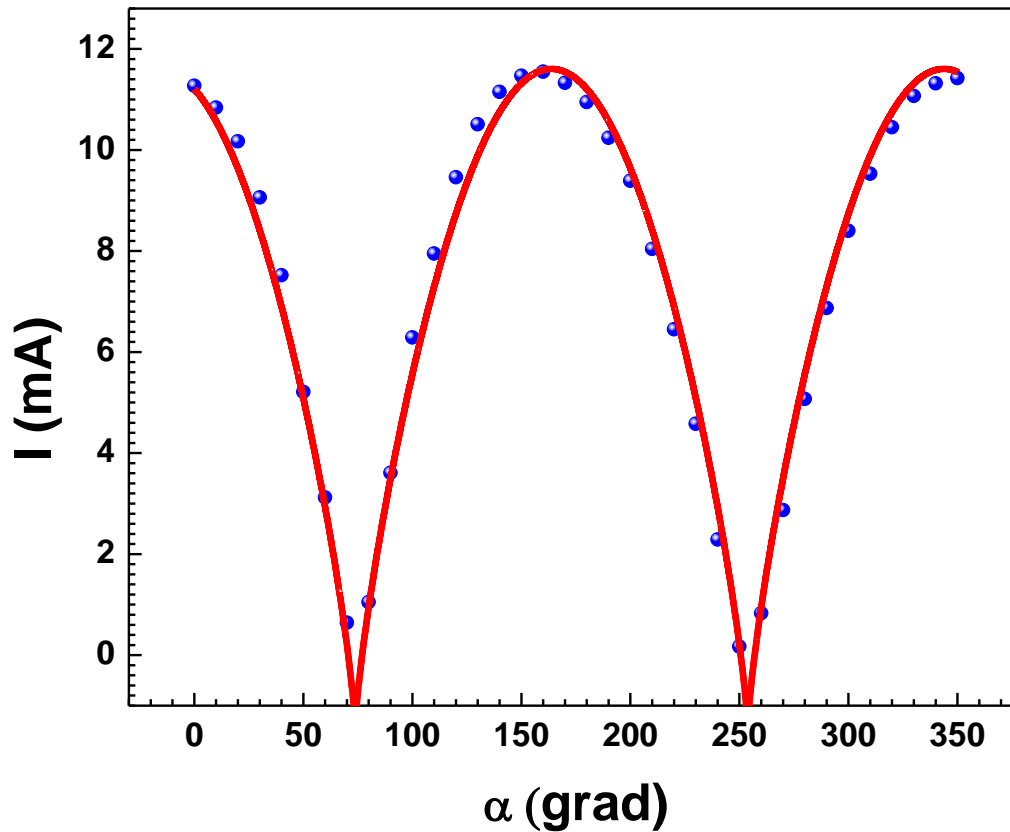

Experimental result.
Fitted to
 $A|\cos(\alpha + \phi)|^n + A_0$



Electric Field Distribution.

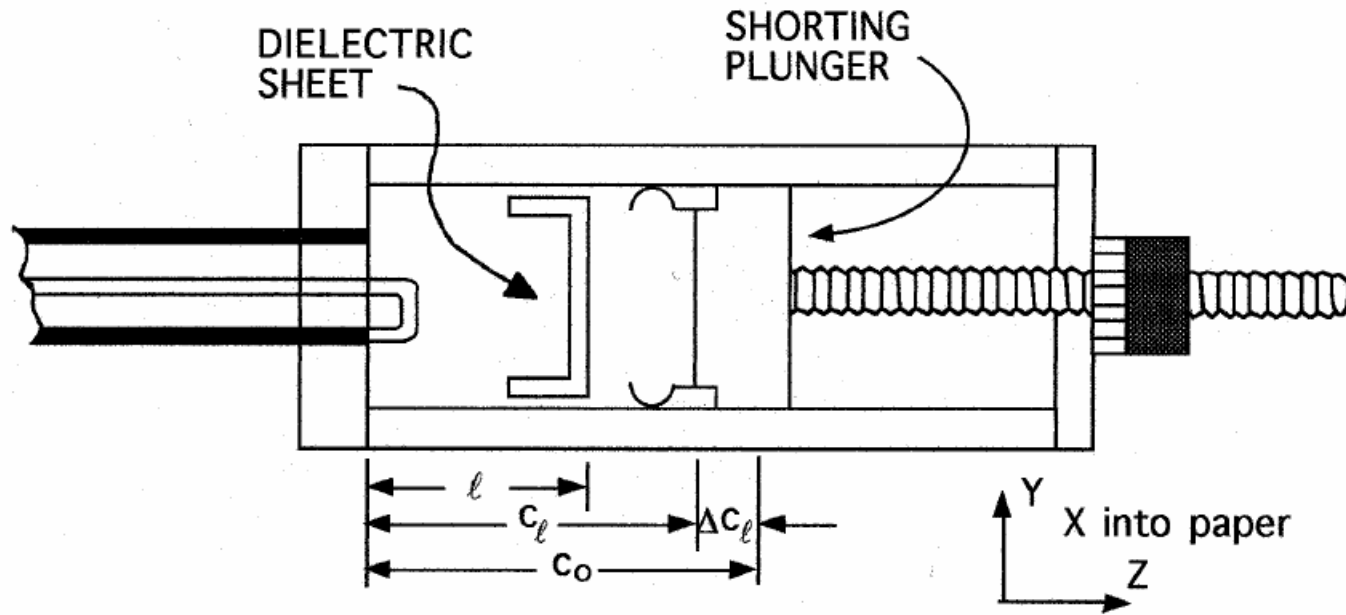

Presence of dielectric reduces length of cavity at a given resonance frequency ω_0 .

This effect grows with the electric field strength E_y .

- (0) Without dielectric the cavity length at resonance is c_0 .
- (1) Place dielectric into cavity and move in 0.5cm steps, l_i .
- (2) At each place tune plunger to resonance and record c_i .
- (3) Plot $\Delta c_i = |c_0 - c_i|$ versus l_i : this measures now E_y vs l !



Electric Field Distribution.

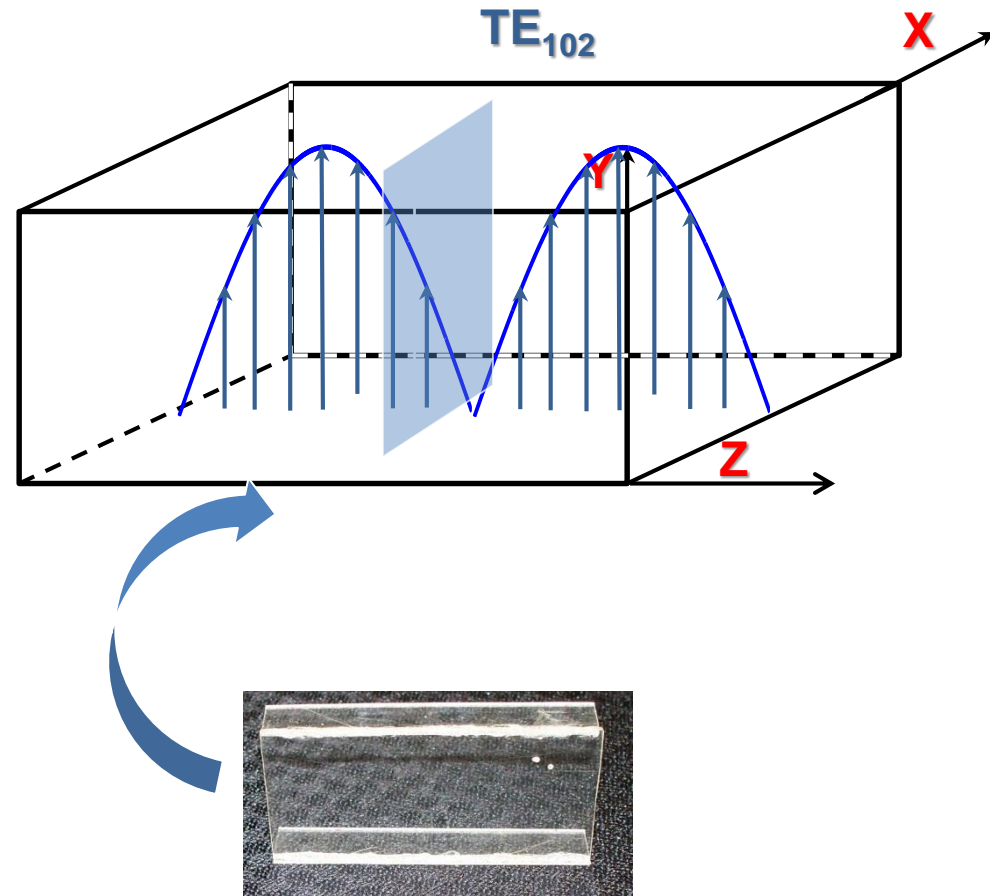
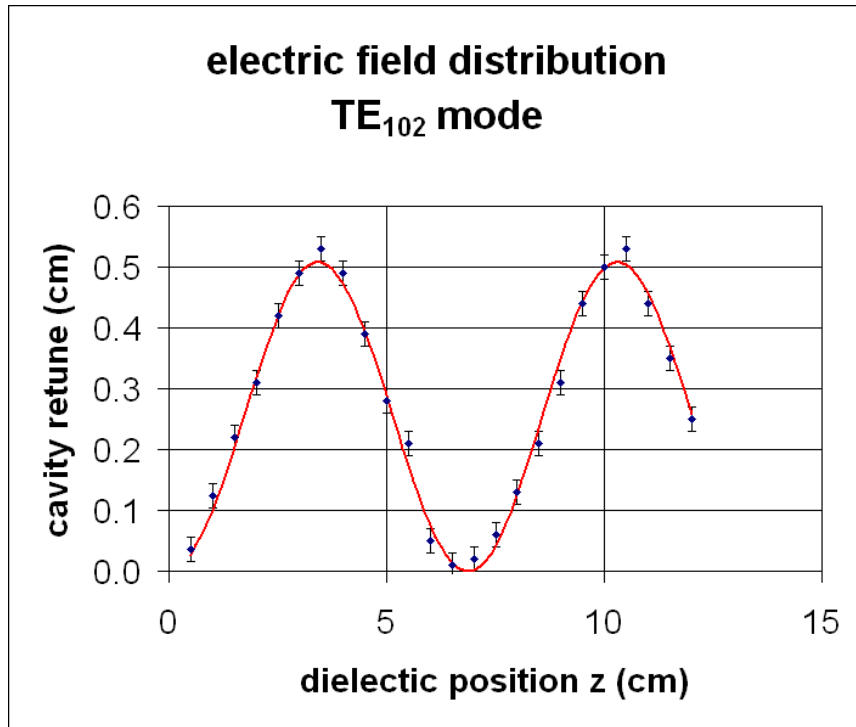

Courtesy of P. Debevec



Calculation of the Quality factor of the Unloaded Cavity

Quality factor (TE₁₀₁ mode) of unloaded cavity can be calculated as:

$$Q_0 = \frac{abc(a^2 + c^2)}{\delta [2b(a^3 + c^3) + ac(a^2 + c^2)]}$$

δ is the skin depth at frequency ω_0

$$\delta = \sqrt{2\rho / \mu\omega}$$

ρ – resistivity of the cavity material
 $\mu = \mu_r \mu_0 \approx \mu_0 = 4\pi \times 10^{-7}$

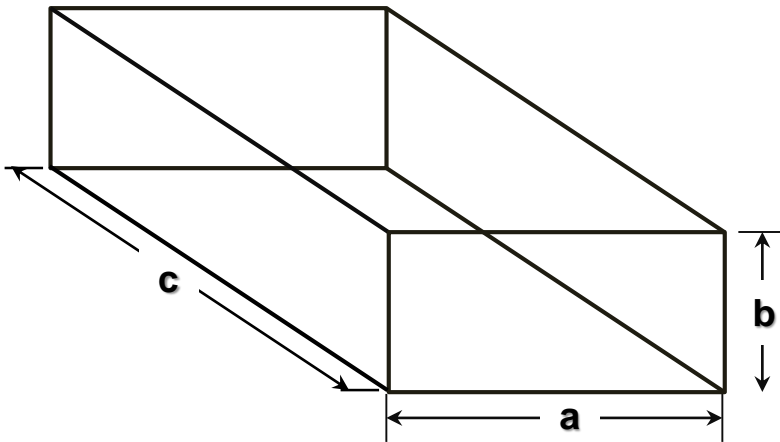

Calculation of the Quality factor of the Unloaded Cavity

For red brass $\rho = 6 \times 10^{-8} \Omega \text{m}$
 $\mu = 4\pi \times 10^{-7}$

$$\delta = 2.25 \times 10^{-6} \text{m}$$

$$\delta = \sqrt{2\rho / \mu\omega}$$

$$a = 7.22 \text{cm}, b = 3.42 \text{cm}, c = 6.91 \text{cm} (\text{TE}_{101})$$

$$Q_0 = \frac{abc(a^2 + c^2)}{\delta [2b(a^3 + c^3) + ac(a^2 + c^2)]}$$

$$Q_0 \sim 7700$$

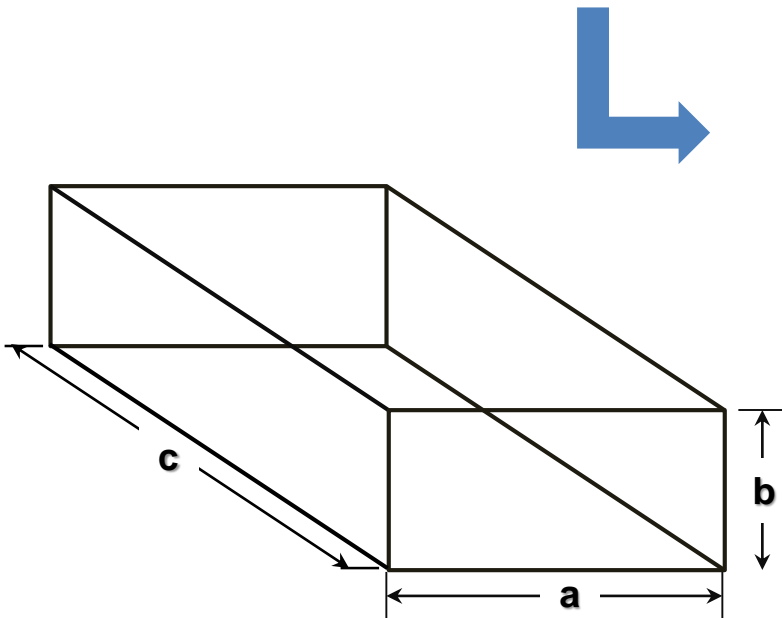

Bragg diffraction.

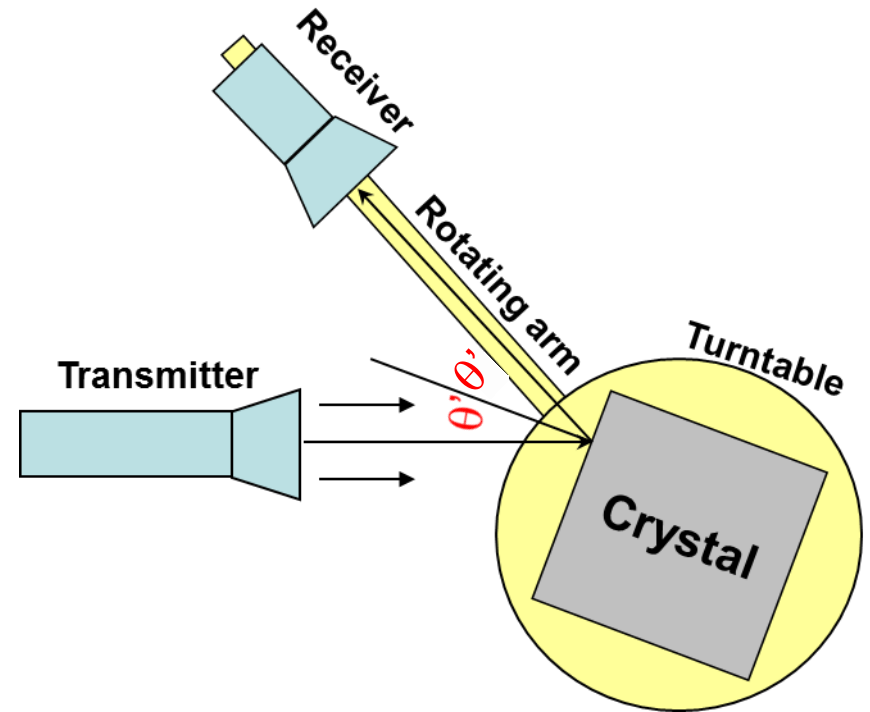
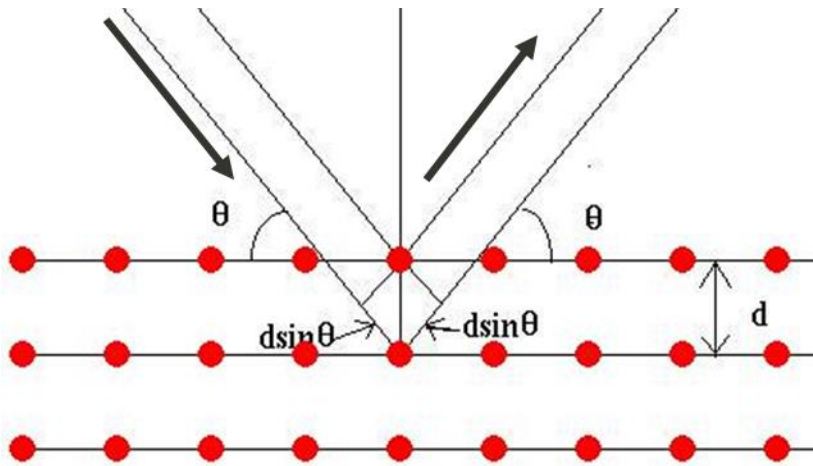

$$n\lambda = 2d \sin \theta \quad \text{Bragg's Law}$$

$$\theta' = 90^\circ - \theta$$



Bragg diffraction. Results.*

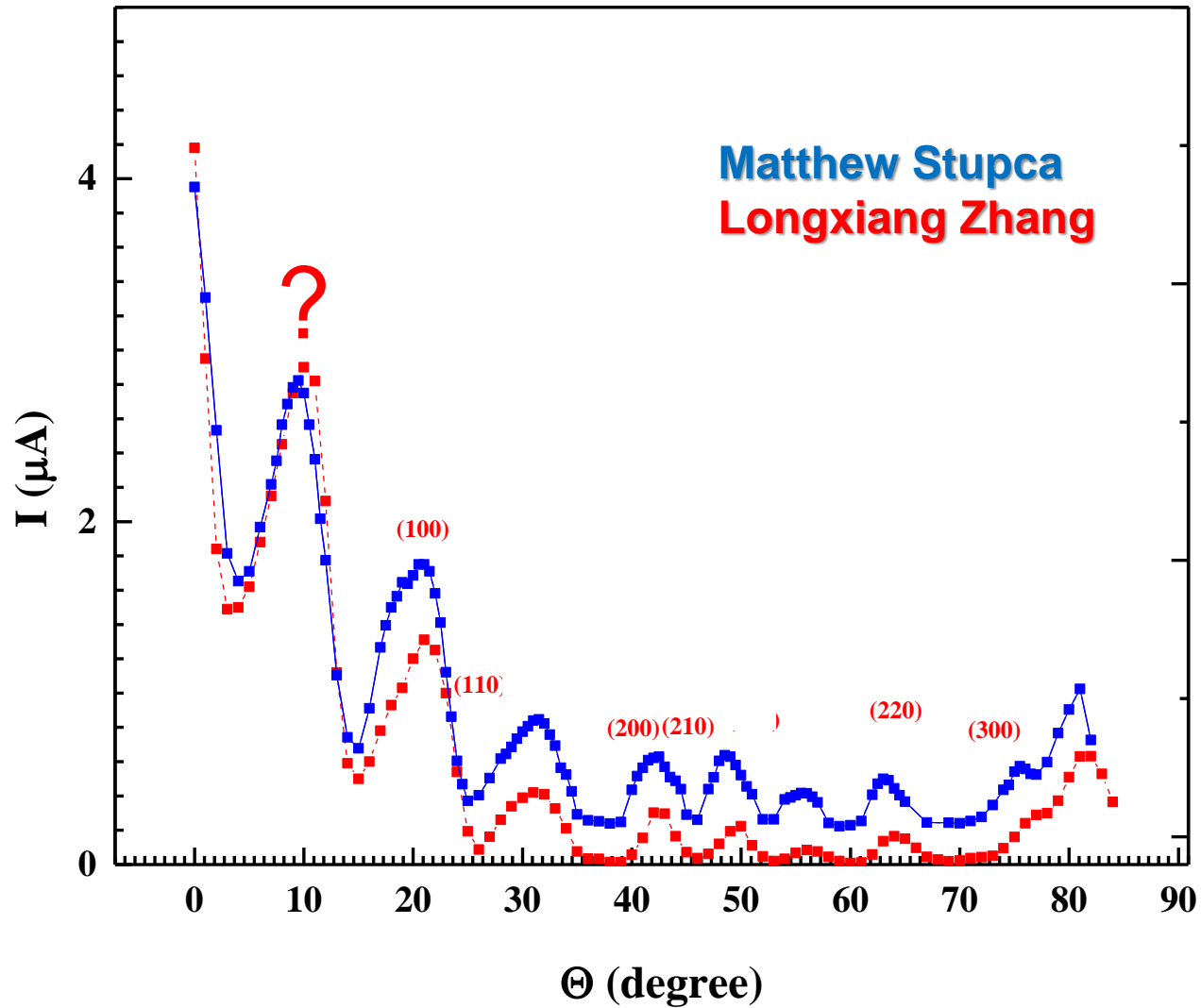

Bragg diffraction. Possible origin of the $\sim 10^\circ$ peak

